

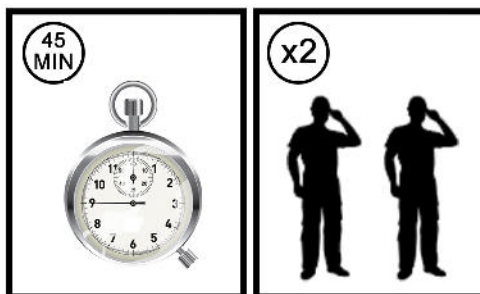







ASSEMBLY INSTRUCTION RECTANGULAR OPEN LEG TABLE

1. PLEASE SEPARATE AND IDENTIFY ALL PARTS. MAKE SURE YOU HAVE ALL OF THE PARTS LISTED
2. PLEASE ASSEMBLE STEP BY STEP AND FOLLOW THE INSTRUCTION.
3. TO AVOID ANY SCRATCH, ASSEMBLE ON A SOFT MAT

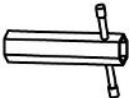

COMPONENTS

	PICTURE	QTY
A		1PC
B		4PCS
C		1PC
D		4PCS
E		4PCS
F		4PCS
G		4PCS
H		1PC

ASSEMBLE TABLE

NOTE

DO NOT tighten screws completely until assembling is completed

STEP 1

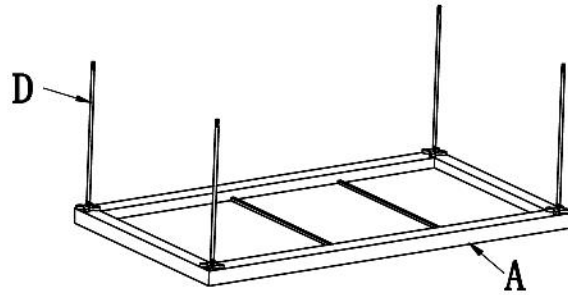

STEP 2

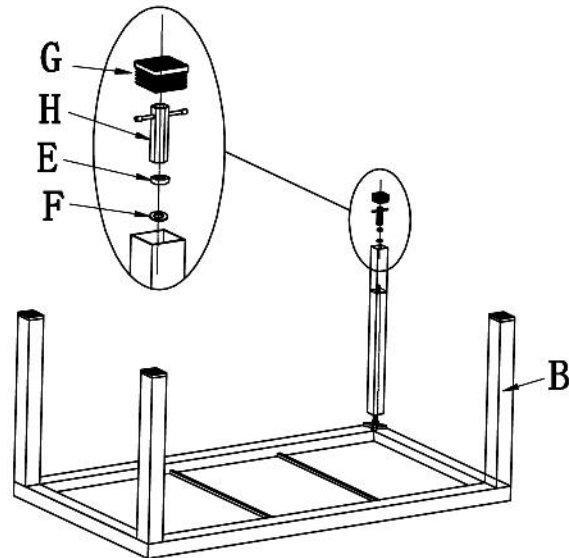

STEP 3

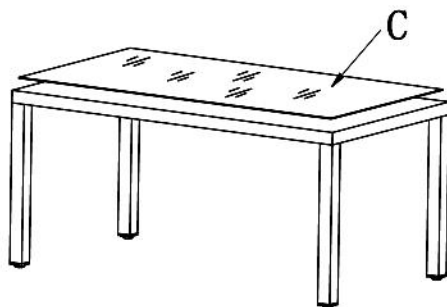

FINISH

